



KW-triO®

Progress ! Harmony ! Innovation

CATALOGUE
www.kw-trio.com

KW-triO®

Outperform, Outlast, Outstanding

Pao Shen Enterprises Co., Ltd.

www.kw-trio.com | ps@kw-trio.com

Tel:886-4-8521174 | Fax:886-4-8521013

No. 162-1 Shen Chiao Rd.,

Da-Tsun Hsiang, Changhua, Taiwan, 51541



The pictures are for reference only. The function and appearance of the product maybe updated without prior notice. The company has the right to change the content at any time. Please confirm before placing the order.



COMPANY PROFILE

KW-triO[®]

Pao Shen Enterprises Co., Ltd. has been manufacturing stationery and office supplies since 1976. We have made a long-term investment into the most advanced high-tech facilities to ensure high quality products, vertical integrated production and excellent management enabling us to earn ISO 9001:2015 accreditation in 1997 and ISO 14001:2015 in 2017.

The brand name "KW-triO" has become synonymous with trendsetting, becoming a worldwide leading manufacturer of desk top accessories as well as hand tools and paper trimmers/guillotines for export to over 110 countries. To keep up with fashion, design and a competitive market, we have a strong R&D team of over 100 technical staff and diversified precise machines for ongoing production of our own brand "KW-triO" and OEM/ODM projects. The "KW-triO" business statement is "Progress, Harmony and Innovation." Our goal is to satisfy your demand and create a comfortable and friendly working environment for you. We want Kw-triO always be your first choice.

Pao Shen Enterprises Co., Ltd.
Chairman

Jackson Huang

CONTENTS

01 Stapler

- P.05 No. 10 Stapler
- P.06 24/6 Stapler
- P.06 Electric Stapler
- P.07 Flat Clinch Stapler
- P.10 Blister Packs
- P.11 Stationery Gift Set
- P.12 Effortless Stapler
- P.14 Plier Stapler
- P.14 Long Reach Stapler
- P.15 No Staple Stapler
- P.16 Heavy Duty Stapler
- P.20 Gun Tacker



02 Staple Remover/Staples

- P.23 Staples (Staple Pins)
- P.24 Staple Remover

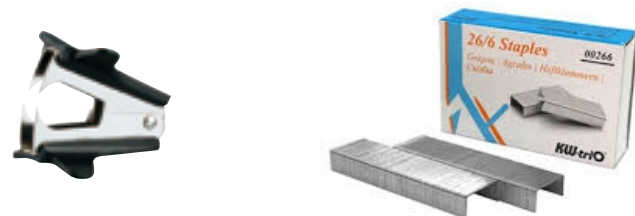

03 Punch

- P.26 Electric Punch
- P.27 Small Punch
- P.28 Medium Punch
- P.29 Large Punch
- P.30 Heavy Duty Punch
- P.32 3 Hole Punch
- P.33 4 Hole Punch
- P.34 Effortless Punch
- P.36 1 Hole Punch
- P.37 Spare Parts (Replacement Set)
- P.38 Heavy Duty 1 Hole Punch
- P.39 Heavy Duty Corner Rounder
- P.40 Corner Rounder



04 Miscellaneous

- P.41 Name Card Box
- P.41 Call Bell / Tally Counter / Spike File
- P.42 Cutter
- P.43 Cutting Mat
- P.44 Book End
- P.45 Scissors
- P.46 Tape Dispenser / Carton Sealer



05 Auto Numbering Machine

- P.47 Auto Numbering Machine



06 Pencil Sharpener

- P.48 Electric Pencil Sharpener
- P.49 Manual Pencil Sharpener



07 Paper Trimmer / Guillotine

- P.50 Metal Trimmer
- P.51 ABS Trimmer
- P.52 Rotary Trimmer
- P.53 Heavy Duty Trimmer (150 Sheets)
- P.54 Heavy Duty Trimmer (450 Sheets)
- P.55 Heavy Duty Trimmer (550 Sheets)



01

STAPLERS

STAPLERS No. 10



5106 ■■■■

- Pollex No.10 stapler
- Major material : Plastic
- Metal bar

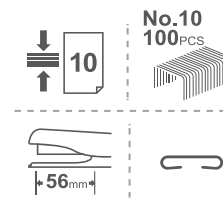

Built-in staple
remover



5109 ■■■■

- Modish No.10 stapler
- Major material : Plastic
- Built-in staple remover

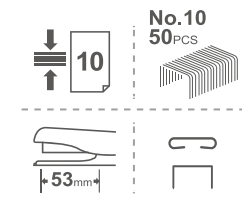

Built-in staple
remover



5270 ■■■■

- Square-cap No.10 stapler
- All metal construction with plastic cover

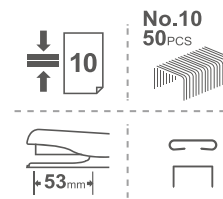

Built-in staple
remover

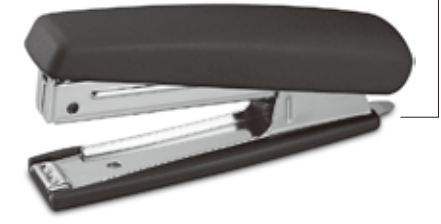

5102 ■■■■

- Modish No.10 stapler
- Major material : Plastic
- Built-in staple remover

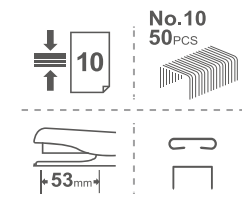

Built-in staple
remover



5201 ■■■■

- Modish No.10 stapler
- Major material : Plastic
- Built-in staple remover

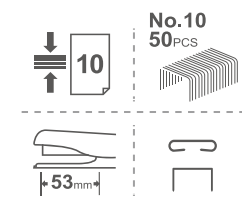

Built-in staple
remover

Mini Stapler

5103T ■■■■

- Mini stapler
- Major material : Plastic
- Built-in staple remover

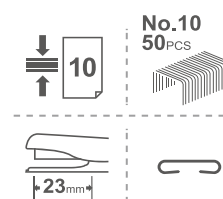

Built-in staple
remover



Adjust depth

Low staple indicator



5990

Electric Stapler

- Electric stapler
- Quality metal anti-jam constructions
- Front loading

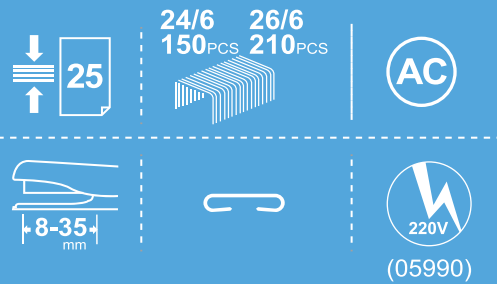

STAPLERS 24/6



5871

- Classic stapler
- All metal construction with plastic cover
- Non-slip base
- Metal bar

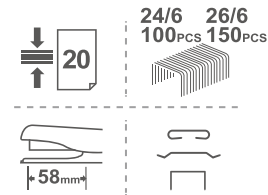

Flat Clinch

Present your work with satisfaction.

Flat clinch reduces the paper stack by 30%

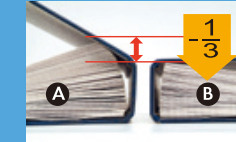

Neat and 1/3 reduced paper stacks

- A. Permanent feature
- B. Flat clinch feature



Built-in staple remover

5675

- Bias flat clinch half-strip stapler
- Major material : Plastic
- Metal bar

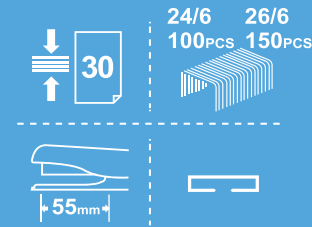

STAPLERS 24/6



5537

Metal

- Classic half-strip stapler
- Metal construction
- Metal bar

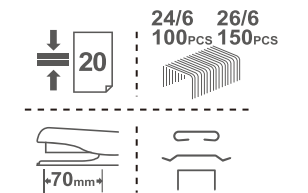

Mini Stapler

Suitable for any occasion.



5665

- Dolphin half-Strip stapler
- Major material : Plastic

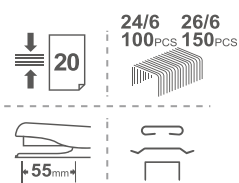

5566

- Pollex half-strip stapler
- Major material : Plastic
- Metal bar

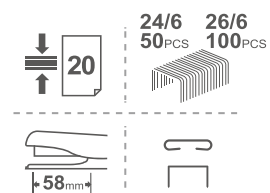

5512T

- Mini stapler
- Major material : Plastic
- Built-in staple remover

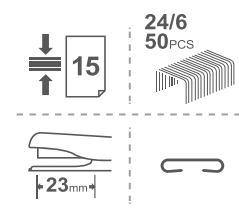

5547 Metal

- Classic half-strip stapler
- Metal construction
- Metal bar

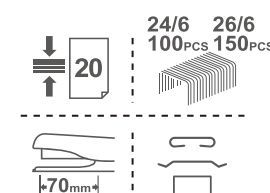

55Y7 Metal **NEW**

- Classic stapler
- All metal construction with plastic cover
- Non-slip base
- Metal bar

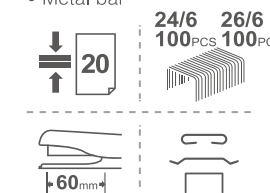

5660 Metal

- Classic half-strip stapler
- Metal construction
- Metal bar

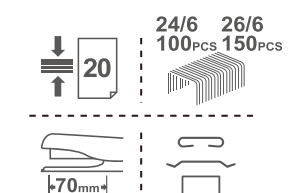

Soft grip cushion

40
Sheets



5568 
Metal

- Classic full-strip stapler
- Metal construction
- Metal bar

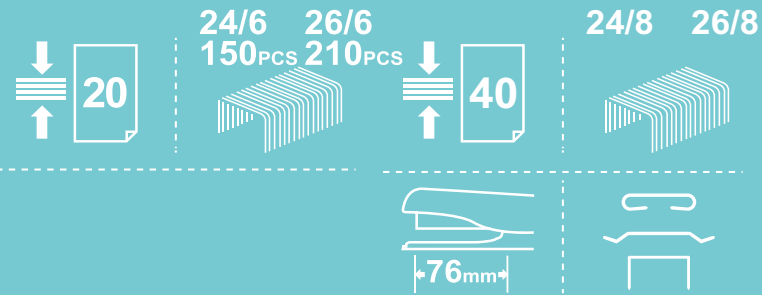

STAPLERS 24/6

Soft grip cushion



Anti-slip base

5558H 
Metal

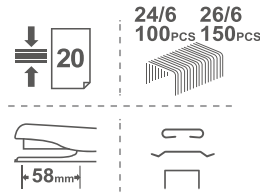

- Pollex metal half-strip stapler
- Soft grip cushion
- Metal bar



MACARON GIFT SET



6351 **NEW**

- Punch  / Stapler  / Pencil Sharpener 
- Easy to use and carry
 - Colorful and intricate design
 - Major material: Plastic
 - Comes in a display box



For more information of operation.

Stapler
5403   



55A3

   
Metal

- Twist half strip stapler
- Major material: Metal
- Built-in staple remover
- Easy stand up or lay out

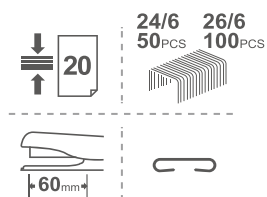

(055A3)
Metal bar

Built-in staple remover

Safety protection



5620 
Metal

- Classic half-strip stapler
- Metal construction
- Metal bar

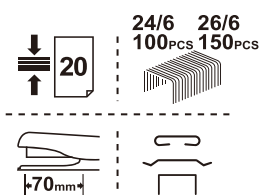

5820 
Metal

- Classic full-strip stapler
- Metal construction
- Metal bar

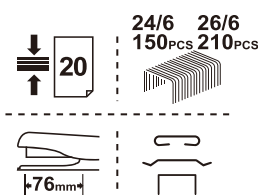

Punch
9433   

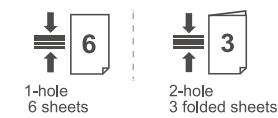

Pencil Sharpener
3423   



Blister Packs

No Staple Stapler

5299

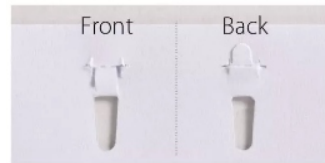

24/6 Staplers



5512T

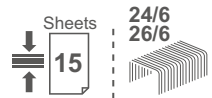

55A3M

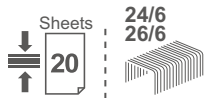

5566M

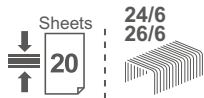

5631 Flat Clinch

- Atomo effortless flat-clinch half strip stapler
- Plastic body with lever-tech quality steel mechanism
- Front loading

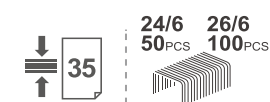

No.10 Staplers



5103T



5109TM



5304M

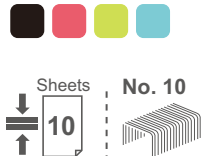

Flat Clinch **NEW**



5385

- Flat clinch mini stapler
- Flat clinch to save 30% space for documents



STATIONERY GIFT SET

6341



Packing 06/12

- 055A3-Stapler
- 09009-Punch
- 03305-Tape Dispenser
- 03513-Cutting Knife
- 04203-Clip Dispenser
- 050P8-Stapler Remover
- 00266-Staples



6339



Packing 12/48

- 055A3-Stapler
- 09109-Punch
- 00246-Staples



6342M



Packing 12/48

- 05165-Stapler
- 090X8-Punch



6074

Packing 06/12

- 05516-Stapler
- 090E0-Punch
- 0508B-Staple Remover
- 00246-Staples



EFFORTLESS STAPLER

Flat Clinch

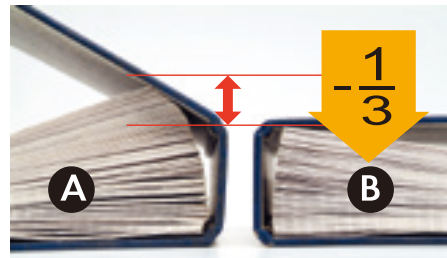

Neat and 1/3 reduced paper stacks

- A. Permanent feature
 B. Flat clinch feature

NEW

5385

- Flat clinch mini stapler
- Flat clinch to save 30% space for stacking documents

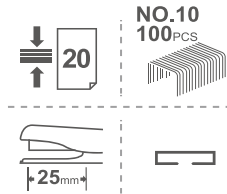

Top Loading Staples

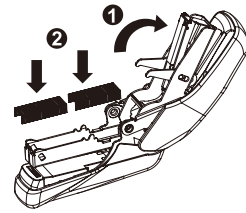

-50%
Effortless

Rubber grip



Atomo **EASYtech** Flat-Clinch Stapler

Save effort and save space for paper stacks.



5631

- Atomo effortless flat-clinch half strip stapler
- Plastic body with lever-tech quality steel mechanism
- Front loading

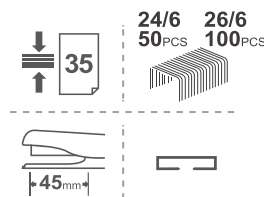

Flat clinch reduces the paper stack by **50%**

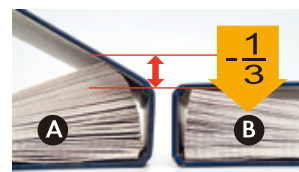

Neat and 1/3 reduced paper stacks

- A. Permanent feature
 B. Flat clinch feature



Button for loading staples

Built-in staple remover

-50%
Effortless

PATENTED

EFFORTLESS STAPLER

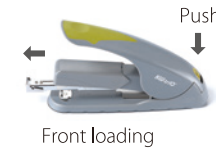

Front loading

-60%
Effortless

Soft grip handle



5618

- Lever-tech effortless half strip stapler
- Plastic body with lever-tech quality steel mechanism
- Soft grip handle

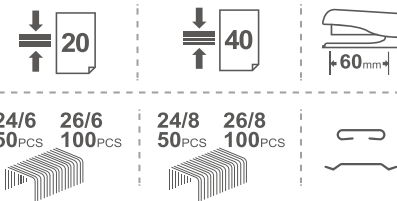

-70%
Effortless

Soft grip handle

5012

- Heavy duty lever-tech effortless stapler
- Plastic body and quality steel components
- Front loading
- Soft grip handle

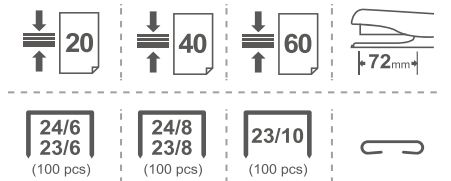

Heavy Duty



Button for loading staples

Adjust depth and remove jammed staples

-40%
Effortless

5004

- Lever-tech effortless heavy duty stapler
- Plastic body with quality steel components
- Front loading

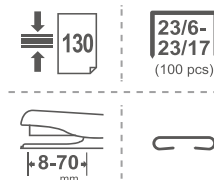

Anti-slip base

-40%
Effortless

5005

- Lever-tech effortless heavy duty stapler
- Plastic body with quality steel components
- Front loading

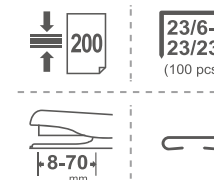

Plier Stapler



5160

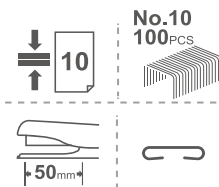

5133

- Plier stapler
- Metal with comfortable dual plastic handle cover

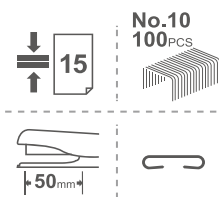

How to load staples ?

Following the diagram 1-3 to load staples.



5742

- Heavy duty plier stapler
- Metal construction
- Rotate anvil for permanent and pin

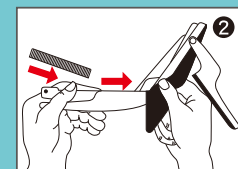

- Long reach stapler
- Major material: Metal
- Rotating anvil allows stapling and pinning
- Calibrated base and adjustable paper stop for precise stapling every time

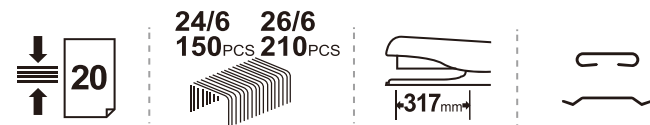

5793

- Heavy duty plier stapler
- Metal with comfortable dual plastic handle cover
- Rotate anvil for permanent and pin

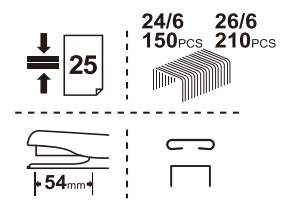

Long Reach Stapler

5900



Non-slip feet

No-Staple Stapler

Fastening paper without staples for ECO friendly stapler.



How to use ?

Be sure to insert paper into the top depth for stapling properly



Easily fasten the paper at corners and sides

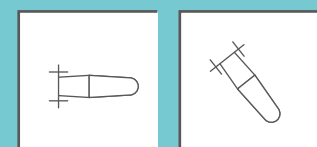

5299



- Submarine no-staple stapler
- Major material : Plastic
- Modern design for easy operation



HEAVY DUTY STAPLER

The versatile heavy duty staplers are perfect for office uses.

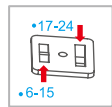
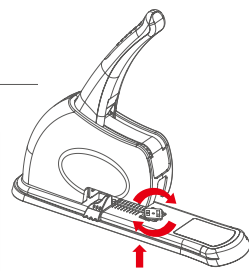

Select anvil clincher (only for 05003)
Rotate Anvil to fit different size of staples.

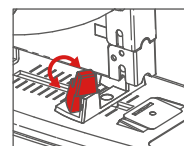

Remove the jammed staples
Rotate the red button inward 90° and press the handle to eject the jammed staples.

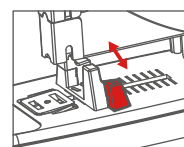

Paper Guide
Pull out the red button to adjust the paper guide to the proper position and push back the red button to lock the paper guide.

Front-Load Heavy Duty Stapler

Feature :

- Robust, extra heavy duty stapler with steel components.
- Comfortable operation and high volumn.



5001

- Heavy duty stapler
- Plastic body and quality steel components
- Front loading

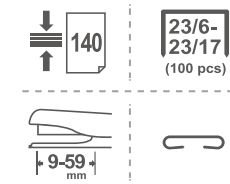

5003

- Heavy duty stapler
- Plastic body and quality steel components
- Front loading

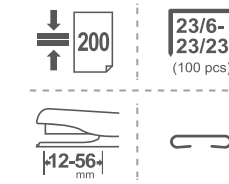

Effortless Stapler



5004

- Lever-tech effortless heavy duty stapler
- Plastic body with quality steel components
- Front loading

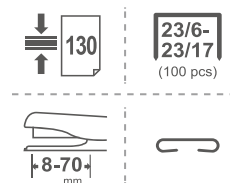

5005

- Lever-tech effortless heavy duty stapler
- Plastic body with quality steel components
- Front loading

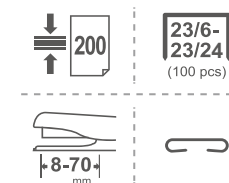

Heavy Duty Stapler

They are perfect for office use and ideal for binding reports, booklets and presentations. Indicating various sizes of staples for choosing proper paper sheets for stapling easily.



50SB

- Heavy duty stapler
- Metal construction & Rubber grip handle
- Rotate anvil for different sizes of staples and capacity
- Non slip rubber base

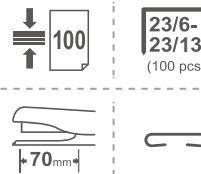

50SC

- Heavy duty stapler
- Metal construction & Rubber grip handle
- Rotate anvil for different sizes of staples and capacity
- Non slip rubber base

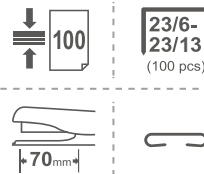

50MA

- Deluxe heavy duty stapler
- Metal construction & Rubber grip handle
- Non slip rubber base
- Rotate anvil for different sizes of staples and capacity

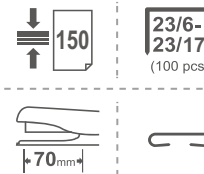

50LB

- Heavy duty stapler
- Metal construction & Rubber grip handle
- Rotate anvil for different sizes of staples and capacity
- Non slip rubber base

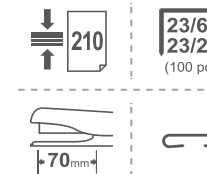

50LBN

- Heavy duty stapler
- Metal construction & Rubber grip handle
- Rotate anvil for different sizes of staples and capacity
- Non slip rubber base

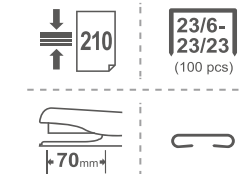

How to use ?

Adjust the depth gauge to a suitable position.

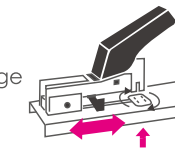

Rotate Anvil to fit different sizes of staples.

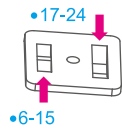

Long Reach Heavy Duty Stapler

Specially designed stapler, perfect for centre-stitching and long reach stapling in magazines, reports, sample books and display sheets. Ideal for both offices and school.

5000

- Long reach heavy duty stapler
- Durable metal construction
- Rotate anvil for different sizes of staples



Adjust depth

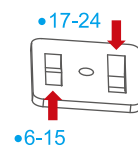

Rotate Anvil to fit different sizes of staples.

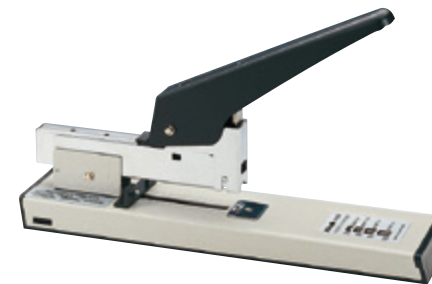

50LC

- Heavy duty stapler
- All tough metal construction
- Non slip rubber base

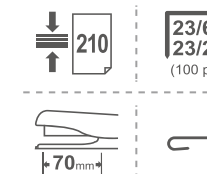

50LCN

- Heavy duty stapler
- All tough metal construction
- Favorite capacity

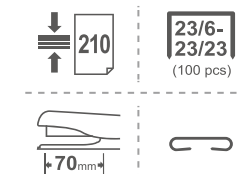

MANUAL TACKERS

ÉASYtech Tacker Range

40~50% Less Squeeze Force



Aluminium Tacker

8540

5in1

- Sleek-robust design with great features
- High tension spring for effortless tacking
- Handle lock allows easy and safe storage
- 5 Way aluminum tacker
- Bottom loading (easy staple loading & clearing)

10.6mm 6-14mm	11.4mm 6-16mm	10.6mm 6-16mm	10-14mm 7.6	12-16mm 18G
0T1 (T50)	53	13		

-50%

PATENTED

TAIWAN EXCELLENCE 2018



ÉASYtech Tacker Range

40-50% Less Squeeze Force

*When compared to leading competitor.

Plastic Tacker

Lightweight and easy to operate

8502

- 2-in-1 plastic tacker
- Rear loading
- Safety handle lock
- Compact design

11.4mm 6-8mm	53	12.85mm 6-8mm	23
-----------------	----	------------------	----

2in1



2in1

8512

- 2-in-1 metal tacker
- Rear loading
- Safety handle lock
- Compact design to fit your pocket

11.4mm 6-8mm	53	12.85mm 6-8mm	23
-----------------	----	------------------	----

8513

ICONIC

- 3-in-1 metal tacker
- Bottom loading
- Safety handle lock
- Beautiful iconic design

11.4mm 6-10mm	53	12.85mm 6-10mm	23	10.6mm 6-10mm	13
------------------	----	-------------------	----	------------------	----

3in1



8514

3in1

- 3-in-1 metal tacker
- Bottom loading
- Safety handle lock
- Beautiful iconic design

11.4mm 6-10mm	53	12.85mm 6-10mm	23	10.6mm 6-10mm	13
------------------	----	-------------------	----	------------------	----

STAPLES

Staples are made from galvanized steel wire with a chiseled point for better penetration and reduces jamming and deformation. KW-triO offers a good range of staples varying in size and gauge.

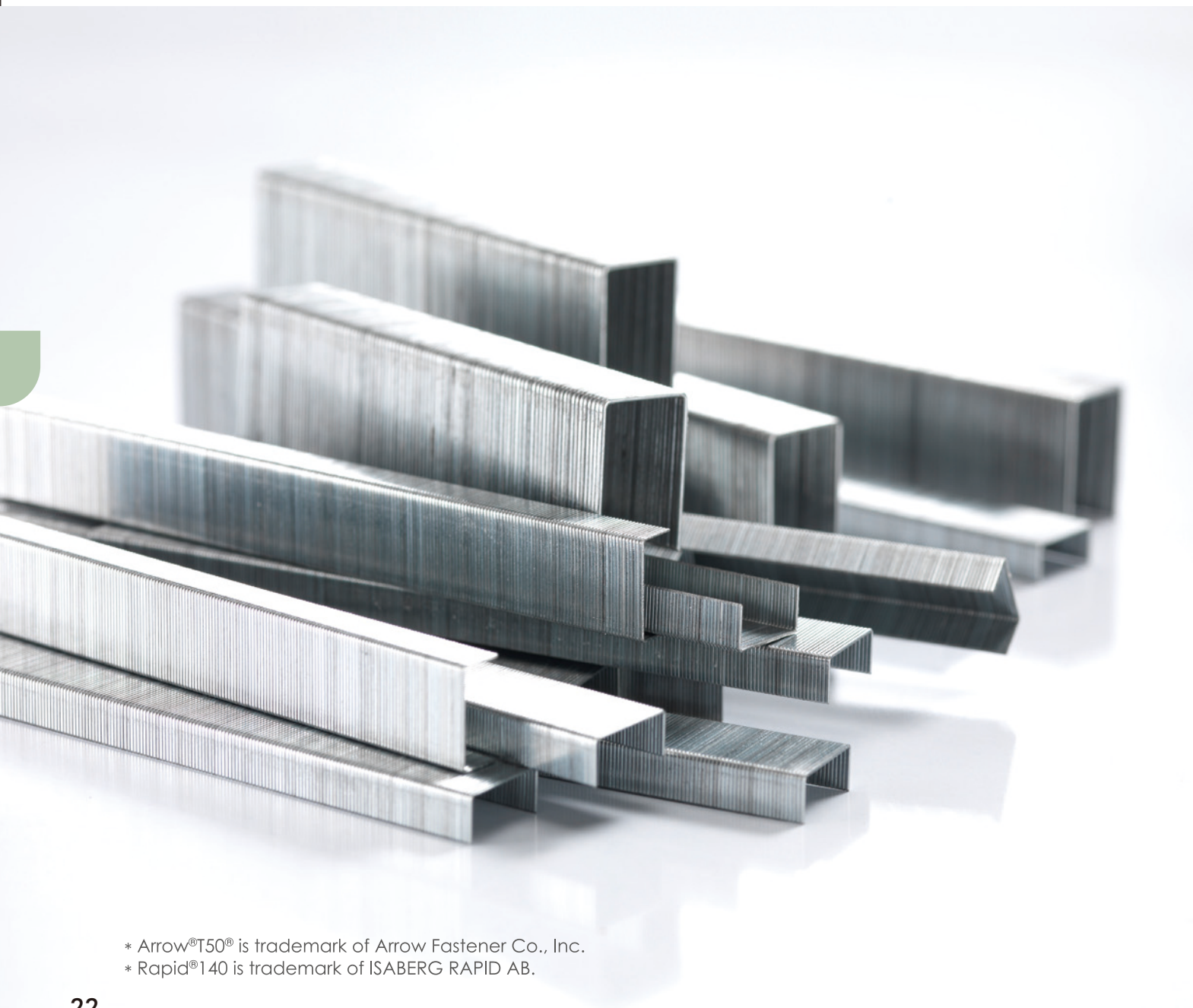
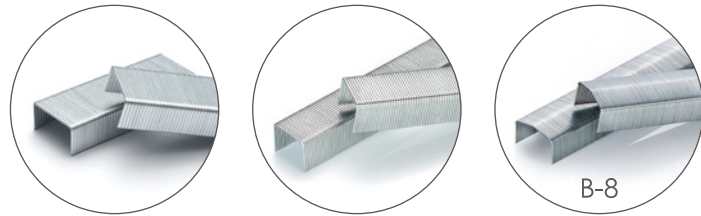

* Arrow®T50® is trademark of Arrow Fastener Co., Inc.
* Rapid®140 is trademark of ISABERG RAPID AB.

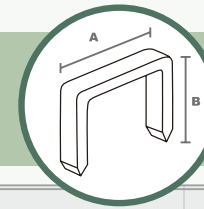

A : Crown
B : Leg Length

ITEM NO.	STAPLES	SIZE (mm)		STICKS (pcs)	INNER CARTON (box)	OUTER CARTON (box)
		CROWN (A)	LEG LENGTH (B)			
00100	No. 10	9.4	5	50	20	800
00266	26/6	12.6	6	100	20	600
00246	24/6	12.8	6	50	20	400
00248	24/8	12.8	8	100	60	240
00236	23/6	12.85	6	100	60	240
00238	23/8	12.85	8	100	20	240
0023A	23/10	12.85	10	100	20	200
0023D	23/13	12.85	13	100	15	150
0023F	23/15	12.85	15	100	15	150
0023H	23/17	12.85	17	100	20	120
0023K	23/20	12.85	20	100	20	120
0023N	23/23	12.85	23	100	20	120
0023P	23/24	12.85	24	100	20	120
00536	53/6	11.4	6	100	40	320
00538	53/8	11.4	8	100	20	240
0053A	53/10	11.4	10	100	20	200
0053C	53/12	11.4	12	100	20	160
0053E	53/14	11.4	14	100	20	160
0134	13/4	10.6	4	100	40	360
0136	13/6	10.6	6	100	40	320
0138	13/8	10.6	8	100	20	240
01310	13/10	10.6	10	100	20	200
01312	13/12	10.6	12	100	20	160
01314	13/14	10.6	14	100	20	160

02

STAPLE REMOVER

5091

- Plier staple remover
- Metal construction

26/6
24/6



5088

- Heavy duty staple remover
- Plastic body with steel components

Under 19mm
leg length

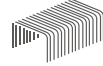

How to remove staples ?

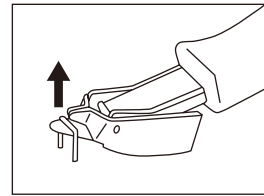
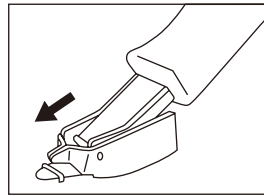

Heavy Duty

5093

- Heavy duty staple remover
- Metal construction

26/6.B8
24/6



23/6-
23/23



Function:

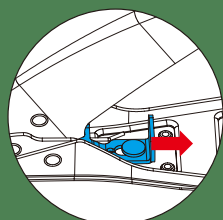
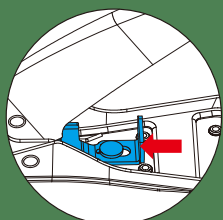

508B

- Staple remover
- Plastic handles with steel components

No.10
No.25



24/6
26/6



03

PUNCH



ELECTRIC PUNCH



Switch bottom to change hole distance
3 hole for 108mm,
2 hole for 70mm

Auto reverse
button for
clearing jams

Folding working table

Clear window
to check punch chips

9591

- Electric 2-3 hole adjustable punch
- Capacity : 30 sheets
- Major material : Plastic cover and metal construction (MOQ 500 PCS)

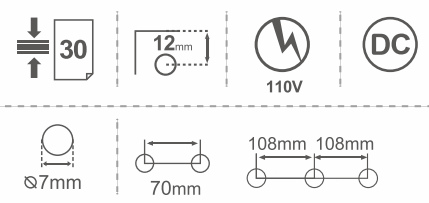

9402

- Electric 2 hole adjustable punch
- Capacity : 12 sheets
- Major material : Plastic cover and metal construction

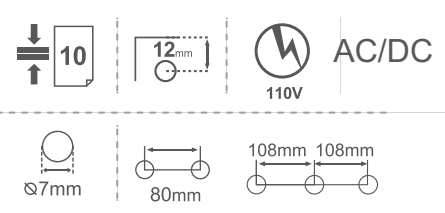

Small Punch 10 Sheets

988



- Typical mini 2-hole punch
- Major material : Metal and plastic

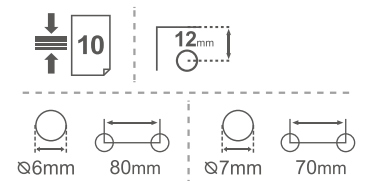

Handle lock



Handle lock

90P0



- Pollex mini 2-hole punch
- Major material : Plastic handle and metal construction

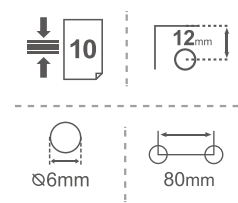

Handle lock

9060



- Stylish mini 2-hole punch
- Major material : Metal and plastic

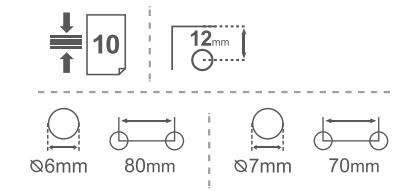

Handle lock

91X8



- Typical mini 2-hole punch
- Major material : Metal and plastic

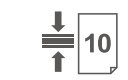

Handle lock

90E0



- Stylish mini 2-hole punch
- Major material : Metal and plastic

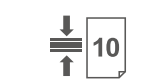

Medium Punch 16 to 25 Sheets



96X8



- Pollex smart 2-hole punch
- Major material : Plastic handle and metal construction

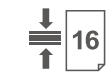

Handle lock



91P0



- Pollex smart 2-hole punch
- Major material : Plastic handle and metal construction

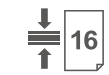

Handle lock



912



- Typical med. 2-hole punch
- Major material : Metal and plastic

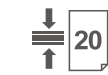

Handle lock

Capacity upgrade



9660



- Stylish med. 2-hole punch
- Major material : Metal and plastic

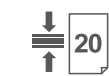

Handle lock



96P0



- Pollex medium 2-hole punch
- Major material : Plastic handle and metal construction

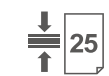

Handle lock



96E0



- Pollex medium 2-hole punch
- Major material : Plastic handle and metal construction

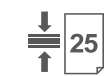

Handle lock

Large Punch 30 to 40 Sheets



Handle lock

978



- Typical heavy duty 2-hole punch
- Major material : Metal and plastic



Handle lock

9760



- Stylish heavy duty 2-hole punch
- Major material : Metal and plastic



Handle lock

98E0



- Pollex heavy duty 2-hole punch
- Major material : Plastic handle and metal construction



Handle lock

97P0



- Pollex heavy duty 2-hole punch
- Major material : Plastic handle and metal construction



Heavy Duty: 2 Hole Punch 65 to 100 Sheets

93Y0

- Yoho heavy duty 2-hole punch
- Major material : Aluminum, metal and plastic

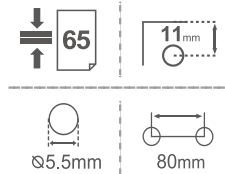

Handle lock



Handle lock

9670

- Heavy duty 2-hole punch
- Major material : Metal

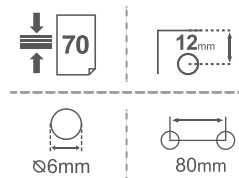

Heavy Duty: 2 Hole Punch 150 to 200 Sheets



Modish and ergonomic handle

Handle lock



9520

- Power 2-hole punch
- Major material : Zinc handle and plastic base
- Replacement cutters see : [page 37](#)

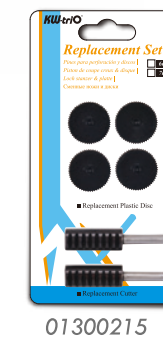

01300215

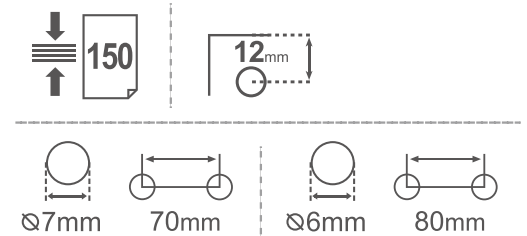

9380

- Power 2-hole punch
- Major material : Metal
- Replacement cutters see : [page 37](#)

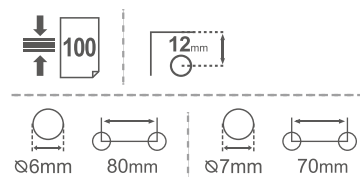

01300215



Handle lock

9330

- Power 2-hole punch
- Major material : Aluminum, steel and plastic
- Replacement cutters see : [page 37](#)

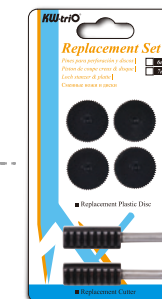
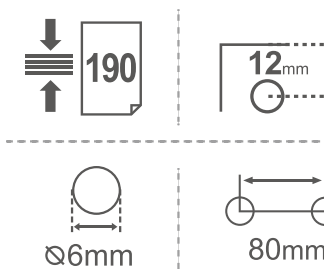

01300215



Handle lock

3 Hole Punch



Handle lock

999

- Classic adjustable 3-hole punch
- Major material : Metal and plastic

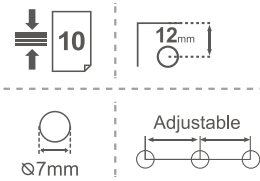

Handle lock

9630 Adjustable

- Adjustable heavy duty 3-hole punch
- Major material : Metal and plastic

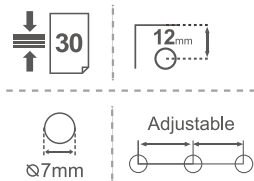

Handle lock

9530

- Power 3-hole punch
- Major material : Zinc handle and plastic base
- Replacement cutters see : [page 37](#)

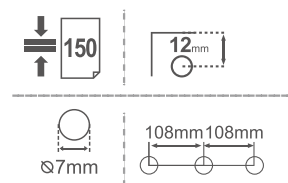

01300215

4 Hole Punch



Handle lock

999D

- Classic adjustable 4-hole punch
- Major material : Metal and plastic

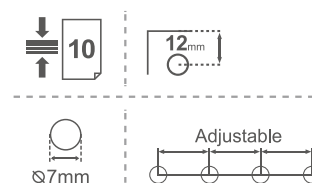

Handle lock



9640 Adjustable

- Adjustable heavy duty 4-hole punch
- Major material : Metal and plastic

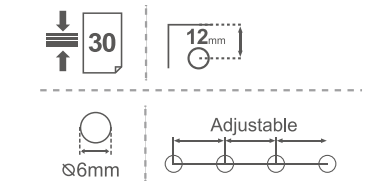

EASYtech Power Saving Punch

300 Sheets

POWER SAVING

Modish cushioned ergonomic rotating handle



01300215

955C

- Easy-Tech super 3-hole punch
- Major material : Aluminum construction
- Jammed cleaning tools included
- Replacement cutters see : [page 37](#)

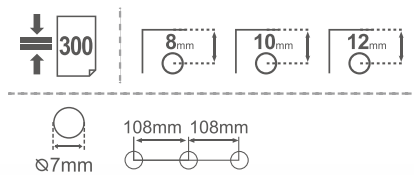

Chip cleaning tools placed under the bottom of base

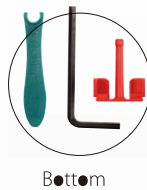

Bottom

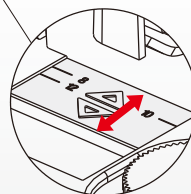

Adjustable depth: 8mm, 10mm, 12mm

9540

- Power 4-hole punch
- Major material : Zinc handle and plastic base
- Replacement cutters see : [page 37](#)

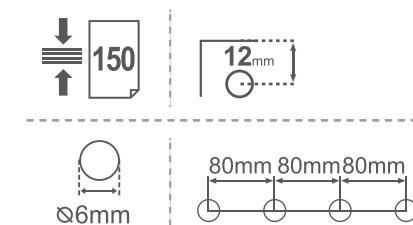

01300215

Handle lock



EASYtech Power Saving Punch

200
Sheets

-40%

9556

- Easy-Tech heavy duty 2-hole punch
- Major material : Plastic cover with sturdy zinc construction
- Replacement cutters see : [page 37](#)

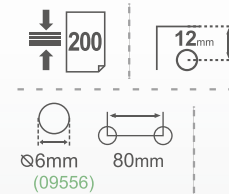

01300215



Lever-tech mechanism offers easy and light punching performance

Handle lock

Security: Finger guard for safety

- Accessory tool box :
- Storage box for hollow cutters and plastic discs.
 - Two spare hollow cutters and four spare discs are optional.

Punching 4 hold by using paper guide

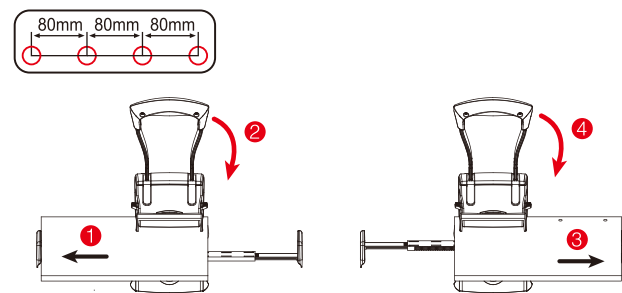

Easy cutter replacing

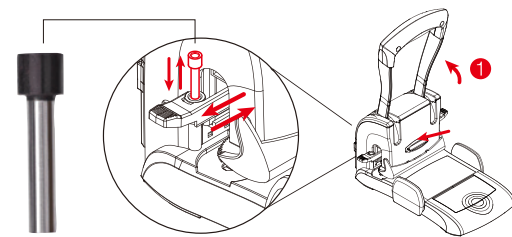

9546

100
Sheets

- Easy-Tech heavy duty 2-hole punch
- Major material : Plastic cover with sturdy zinc construction
- Replacement cutters see : [page 37](#)

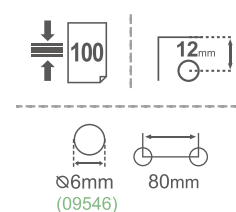

01300215



Handle lock

EASYtech Power Saving Punch

9550

2 Hole Punch

300
Sheets

- Easy-Tech super 2-hole punch
- Major material : Aluminum construction and plastic
- Jammed cleaning tools included
- Replacement cutters see : [page 37](#)

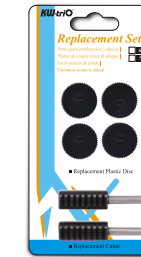
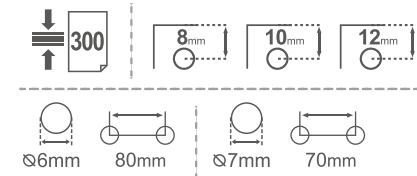

01300215



Bottom

Handle lock

Punch for 150 sheets & 300 sheets

Punch 150 sheets at first time.

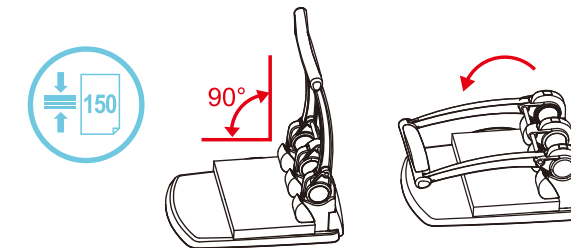

Raise lever over than 90° to set up and punch for another 150 sheets.

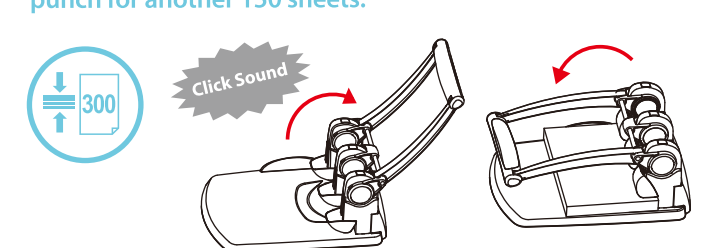

Modish cushioned ergonomic rotating handle

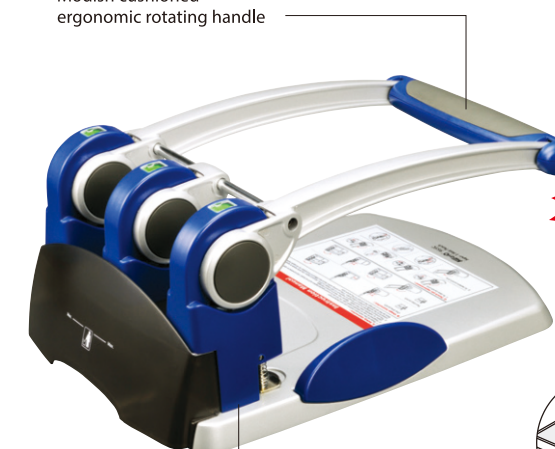

Handle lock

Chip cleaning tools placed under the bottom of base



Bottom

Adjustable depth: 8mm, 10mm, 12mm

3 Hole Punch

POWER
SAVING

300
Sheets



01300215

9550C

- Easy-Tech super 3-hole punch
- Major material : Aluminum construction
- Jammed cleaning tools included
- Replacement cutters see : [page 37](#)

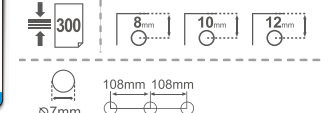

1 Hole Punch



97A0

- Hand-held one hole punch
- Major material : Metal



97D0

- Hand-held one hole punch
- Major material : Metal



Slot Punch

Slot punching tool for ID card and credentials



Chrome

9772

- Hand-held slot punch
- Major material : Metal

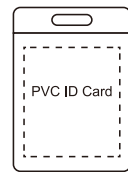

9210

- One hole punch
- Major material : Metal and plastic



Eyelet Hole Punch Plier

9717

- Eyelet hole punch plier
- Major material : Zinc & Metal



How to use ?

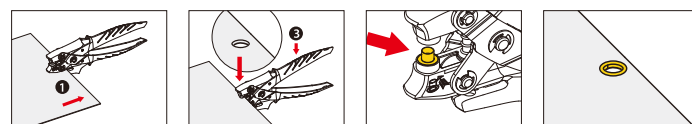

Punching a hole on paper

Put eyelet on the hole

Put "step1" paper onto eyelet and squeeze the handle firmly

Reinforced hole to protect paper & easy storage

One hole punch

Related eyelets used:

09703 / 09704 / 09705 / 09707
(Please refer to page 62)

Inserting depth adjusted by loosening and tightening the screw (from 5mm-12mm)

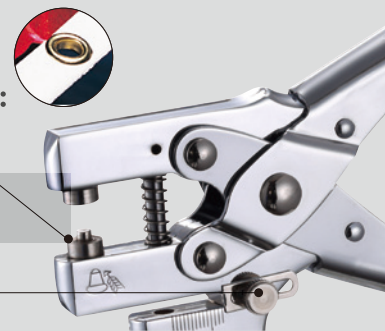

Spare Parts

Replacement cutter

One cutter in a zip bag

Item No.	Applicable model	Hole dia.	Hole distance
01300178	09380	6 mm	80 mm
01300684	09556	6 mm	80 mm
01300545	09550/0955C	7 mm	70/108 mm
01300555	09550	6 mm	80 mm
01300659	09520	6 mm	80 mm
01300159	09330	6 mm	80 mm
01301629	09546	6 mm	80 mm



Replacement plastic disc

Item No.	Applicable model	Item No.	Applicable model
01100001	09330	01110884	09556/09555
	0931C	01106090	09550/09555
	09380	01111858	09546/09545
	09580		
	09520		
	09530		
09540			



Replacement plastic disc

4 discs in a pack

Item No.	Applicable model
01100753	09330
	09380
	09580
	09520
	09530
09540	
01107843	09550/0955C
01107829	09556/09555
01111859	09546/09545



01100753

Replacement cutter set

2 cutters and 4 discs in a pack

Item No.	Applicable model	Hole dia.	Hole distance
01300215	09330	6 mm	80 mm
01300230	09520/09530	7 mm	70/108 mm
01300214	09520/09540	6 mm	80 mm
01301184	09546	6 mm	80 mm
01300534	09550	6 mm	80 mm
01301041	09550/0955C	7 mm	70/108 mm
01300709	09556	6 mm	80 mm

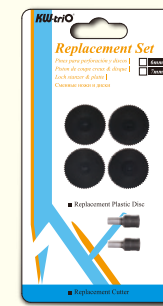

01300667



01300215



01300735

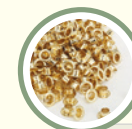

Eyelet

Item No.	Hole dia.	Length	Box
09703	4.8 mm	3.2 mm	250 pcs
09704		4.2 mm	
09705		5.5 mm	
09707		4.6 mm	



Replacement cutter

6 pcs packed by vacuum card

Item No.	Applicable model	Hole dia.	Hole distance
01300001	09528/09540	6mm	80mm
01300002	09527/09530	7mm	70/108mm
01300121	09387	7mm	70mm
01300127	09388	6mm	80mm
01300665	09574	6mm	80mm
01301628	09546	6mm	80mm

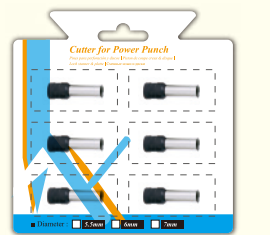
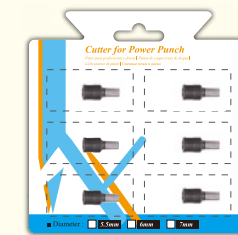

Spare punch head

Item No.	Applicable model
0140001	09990/0999D 09935
0140016	09630
0140052	09640
0140061	09635/0963C

0140016



0140001



0140052

Heavy Duty

1 Hole Power Punch



9522

- Heavy duty one-hole power punch
- Major material : Plastic cover and metal construction
- With centering paper guide



Available accessories

The machine is designed for changing 6 kind of cutters

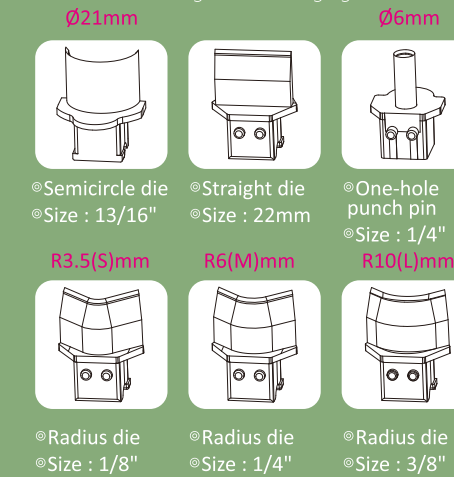

9521

Depth Guide accessory (for semicircle & Hole Punch)



- Corner rounding equipment & power punch
- Major material : Plastic cover and metal construction
- Lever-tech mechanism
- 6 kinds of cutters available



Heavy Duty

Corner Rounder Punch



Accessory tool box
For storage of cutters and discs.

Finished Shapes



Corner Rounder

A good tool to round or trim the corner of paper. The base has a clipping compartment and can be emptied easily. The corner rounder is great for : cutting paper, photos, laminated documents, gift cards and business cards. It will help you complete your tasks easily and satisfy your various desires at work.

9777 ■

Applicable for plastic sheets (up to 0.8mm), cardboard (up to 0.8mm) and paper (up to 1mm)



Corner Rounder Packaging



How to Use



Install the paper guide on the product.



Screw the guide onto the bottom.



Push paper into paper guide and punch down.



Special compartment designed for paper scraps.

9Z194 ■

Applicable for plastic sheets (up to 0.2mm) cardboard (up to 0.2mm) and paper (up to 0.4mm)



Corner Rounder Packaging



How to Use



Put the paper flat on the platform.



Press the round edge of the corner rounder.



Special tray designed for paper scraps.



Cutting machines

Corner Rounder

04

MISCELLANEOUS

Business Card Case

Organize the business card in order with A-Z index tabs.

Metal card file

Index card tabs



Transparent cover



4600 ■■

- Major material : Metal body with plastic cover



4800 ■■

- Major material : Metal body with plastic cover

Call Bell



3A00 ■

- Table call bell
- Clear tone you can't miss
- Chrome finished
- 3-3/8" base diameter

Tally Counter



2450 ■

- Handy tally counter
- Metal casing
- 4 digits, 0-9999
- Automatic reset knob

Spike Files



03A02 ■

- Major material : Metal

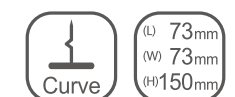

Cutting Knife

Retractable razor knife set.
High grade of cutter blade assures the life for cutting.

3555

- Cutting knife
- Major material : Carbon steel

9mm



3513

- Small cutting knife
- Major material : Carbon steel

9mm



3713

- Heavy duty cutting knife
- Major material : Carbon steel

18mm



3805

- Rotary cutter
- Blade diameter : 28 mm
- Major material : Plastic & High grade blade

3541

- Pocket knife
- Major material : Carbon steel

12mm



Replacement Snap Blades



- A plastic tube : 10 pcs
- Major material : High carbon steel

100638
9mm Small

Used for : 03513 / 03555

100639
18mm Big

Used for : 03713

2 Extra Blades

High grade blades

3804

- Rotary cutter
- Blade diameter : 45 mm
- Major material : Plastic & High grade blade

How to use ?

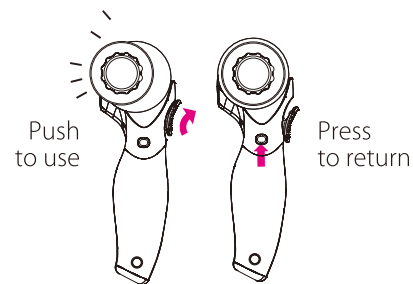

Type of Replacement Blades

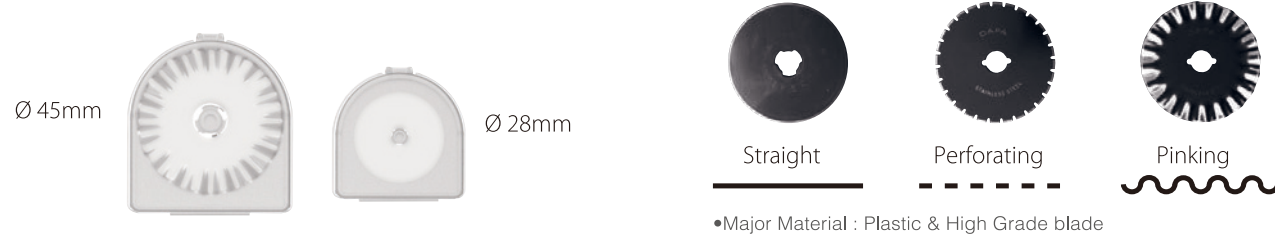

•Major Material : Plastic & High Grade blade

Item No.	Description	Blade diameter	Blade
SB001	Replacement Blade	45 mm	Straight , Perforating , Pinking x 1
SB002			Straight x 3
SB003		28 mm	Straight , Perforating , Pinking x 1
SB004			Straight x 3

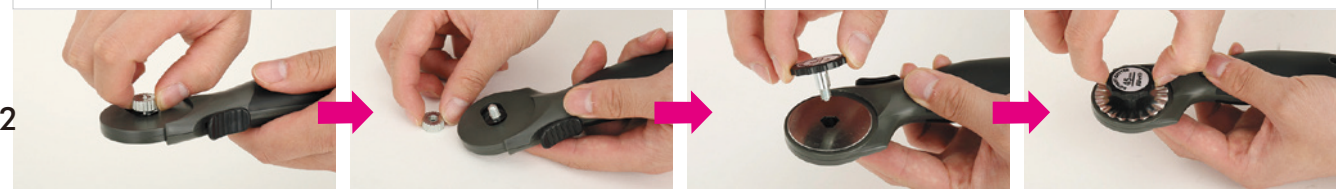

Cutting Mat

Innovative material provides self-healing surface.
Reversible and durable three-layer construction.
Clear and precise centimeter grid line.
Flat surface allows to write and cut smoothly.

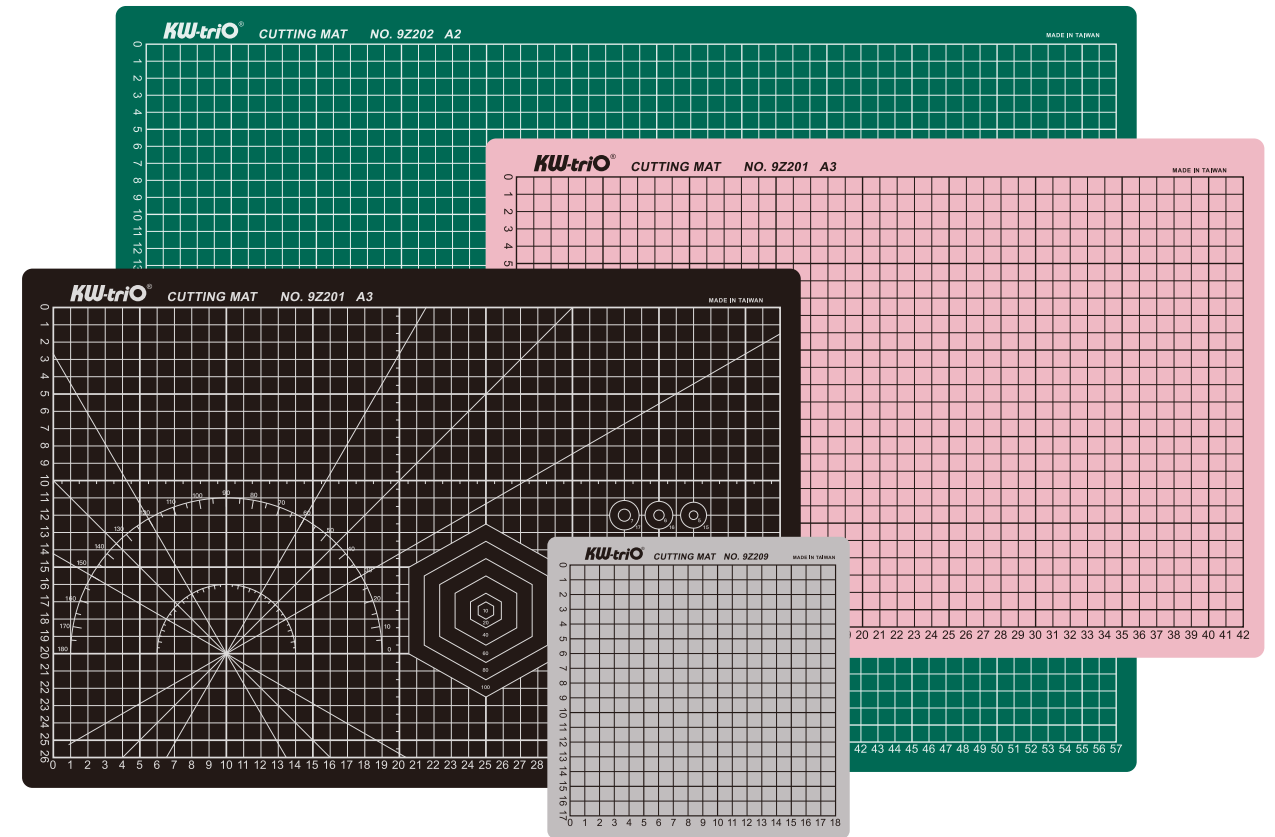

⬆ Backside printing



Item No.	Specification	Size	Thickness	Inches
9Z200	A4	300 x 220 mm	3 mm	9x12
9Z201	A3	450 x 300 mm	3 mm	12x18
9Z202	A2	600 x 450 mm	3 mm	18x24
9Z203	A1	900 x 600 mm	3 mm	24x36

- Self healing cutting mat
- Major material : Plastic
- Double-sided printing available

Bookends

Made of strong, heavy gauge steel with anti-slip bottom. Various colors for choice.

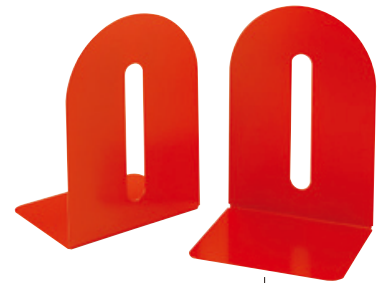

H 8"
200mm

Anti-slip bottom

2210 ■ ■ ■ ■

• Major material : Metal



H 7.25"
185mm

2240 ■ ■ ■ ■

• Major material : Metal



H 6"
150mm

2220 ■ ■ ■ ■

• Major material : Metal



H 8.25"
210mm

2230 ■ ■ ■ ■

• Major material : Metal

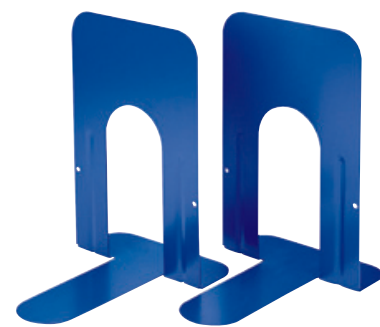

H 9.25"
235mm

2280 ■ ■ ■ ■

• Major material : Metal

Scissors



Good stability , precise.



Laser Engraving.

Non-Slip, soft comfort handles.

Ergonomic design.

JD01 ■ ■

6.5" 7.5" 8"



- 12/144

JD05 ■ ■ ■

6" 7" 8"



Tape Dispenser

Weighted and non-slip feature.
Sharp blade for easy cutting.

(S)



Nonslip base

3305 ■■■

- Mini tape dispenser
- Core : 1"
- Tape width up to : 19 mm
- Tape length up to : 30 m
- Major material : Plastic
- Non-slip Base

(M)



3309 ■■■

- Med. tape dispenser
- Core : 1"
- Tape width up to : 19 mm
- Tape length up to : 33m
- Major material : Plastic
- Non-slip Base

(L)



3311 ■■■

- Heavy duty tape dispenser
- Core : 1" , 3"
- Tape width up to : 24 mm
- Tape length up to : 66m
- Major material : Plastic
- Non-slip Base

Carton Sealer



EX01 ■■

- Core : 3"
- Tape width up to : 50.8 mm
- Tape length up to : 54 m
- Major material : Plastic

Double-edged blade



Tape holder

Friendly handle design

Adjustable breaking mechanism

Spare Parts



5100007

- Replacement pads
- Size : 31x11x6mm

2900012 ■■

2900183 ■■

- Replacement Ink

05

AUTO NUMBERING MACHINE

Ergonomic all-zinc casting frame deep bands and unbreakable wheels.



2100
10 Digits

2090
9 Digits

2080
8 Digits

2070
7 Digits

2060
6 Digits

Model	Wheel	Function Movement	Type	Product Size (mm)	Size of Figures (WxH mm)
02060	6	[0] [1] [2] [3] [4] [6] [12]	000352	62x47x145	5x2.8
02070	7	[0] [1] [2] [3] [4] [6] [12]	0000352	62x47x145	4.2x2.6

[0] [1] [2] ————— Three kinds of continuous manner
[0] [1] [2] [3] [4] [6] [12] ————— Seven kinds of continuous manner

[0 Continuous] 01- 01- 01- 01- 01 ————— Repeat
[1 Continuous] 01- 02- 03- 04- 05 ————— Consecutive
[2 Continuous] 01•01- 02•02- 03•03- 04•04- 05•05 ————— 2 x Repeat
[3 Continuous] 01• 01•01- 02•02•02 ————— 3 x Repeat
↓
[12 Continuous] The same way above ————— 12 x Repeat



WITH TEXTPLATE

2062



- A unique and customizable auto numbering machine
- Self inking 6 wheel numbering machine
- Interchangeable text plate for individual requirements
- Number change consecutive, duplicate or repeat
- Drop-cypher feature

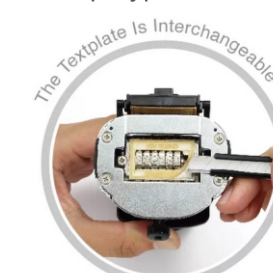

PRINT EXAMPLE :



PENCIL SHARPENER

Electric Pencil Sharpener

Overheat protection circuit

3252



Power lamp

- Electric pencil sharpener
- Major material : Plastic

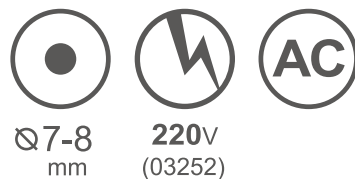

Self-feeding

30FA

- Manifold pencil sharpener
- Major material : Zinc die casting
- Anticlockwise : Sharp pencil lead
- Clockwise : Blunt pencil lead

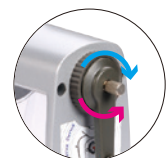

31GA

- Plastic desk sharpener



306A

- Plastic desk sharpener
- Plastic handle



307A

- Metal desk pencil sharpener



305A

- Plastic desk sharpener
- Metal handle



310A

- Plastic desk sharpener



305B

- Plastic desk sharpener



326A

- Plastic desk sharpener



PAPER TRIMMER /GUILLOTINE

METAL

Metal guillotines make easy work of cutting 15 sheets or more of paper at a time and precise cutting. The cutter's blade will not drop down and features either a guard to keep fingers safe.

3912 A4 10



3024 B4 20



Model	3912	3024
Sheets	10	20
Type	Knife	Knife
Cutting Length	335 mm	392 mm
Cutting Height	2.0 mm	2.0 mm
Clamping Type	press	press
Blade Guard	ABS shield	ABS shield
Knife Lock	V	V
Measuring Scale	mm/inch	mm/inch
Format Indication	A6-A4	A6-B4
Table Size (WxD)	305 x 380 mm	305 x 425 mm
Dimensions (WxDxH)	335 x 430 x 380 mm	335 x 480 x 415 mm
Base	Steel	Steel
Color	Blue	Blue

ABS

Additional storage design is ideal for all of your paper and card cutting and trimming projects in your home, school or office.



3921 A4 10

3911 B4 10

3914 A3 10

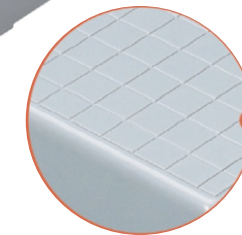

3300 A4



Store assorted stationery

Model	3921	3911	3914	3300
Sheets	10	10	10	10
Type	Knife	Knife	Knife	Knife
Cutting Length	335 mm	385 mm	440 mm	306 mm
Cutting Height	1.0 mm	1.0 mm	1.0 mm	0.7 mm
Clamping Type	press	press	press	press
Blade Guard	ABS shield	ABS shield	ABS shield	-
Knife Lock	V	V	V	V
Measuring Scale	mm/inch	mm/inch	mm/inch	mm/inch
Format Indication	A6-A4	A6-B4	A6-A3	A6-A4
Table Size (WxD)	305 x 350 mm	360 x 425 mm	360 x 480 mm	408 x 176 mm
Dimensions (WxDxH)	335 x 430 x 380 mm	390 x 475 x 400 mm	390x535 x 435 mm	493 x 187 x 353 mm
Base	ABS	ABS	ABS	ABS
Color	Gray	Gray	Gray	Black

ROTARY TRIMMER

Self-grinding rotary blade cuts in both directions and is housed in a rugged cutting head. Full-length paper clamp automatically engages as blade passes by for accurate cuts every time.

3018 A4 15 



3919 A3 15 

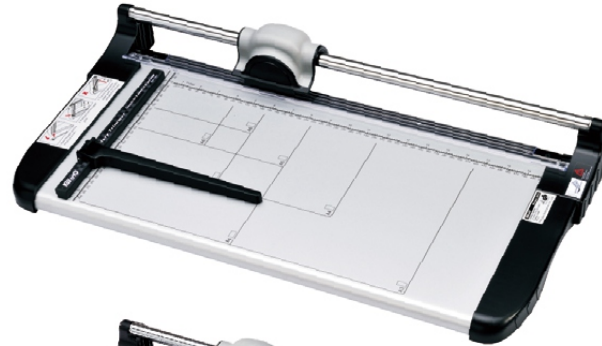

3020 A2 12 

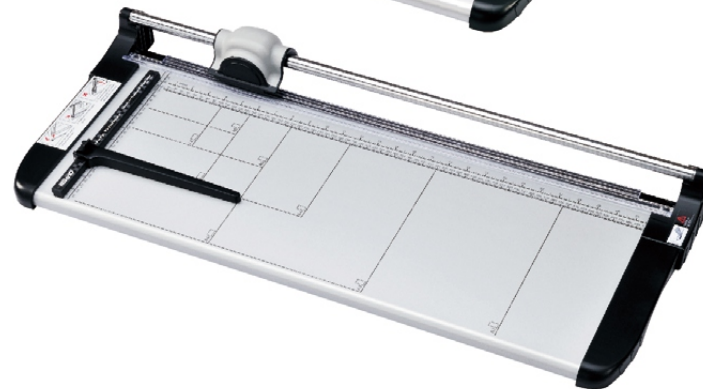



Model	3018	3919	3020	Spare Blade Model: 01300289 Replacement Rotary Cutter Set For 3018, 3919, 3020, 3021, 3022, 3026, 3027
Sheets	15	15	12	
Type	Rotary cutter	Rotary cutter	Rotary cutter	
Cutting Length	360 mm	480 mm	670 mm	
Cutting Height	1.5 mm	1.5 mm	1.2 mm	
Clamping Type	Automatic	Automatic	Automatic	
Blade Guard	Safety Cutting Head	Safety Cutting Head	Safety Cutting Head	
Knife Lock	-	-	-	
Measuring Scale	mm/inch	mm/inch	mm/inch	
Format Indication	A6-A4	A6-A3	A6-A2	
Table Size (WxD)	315 x 546 mm	315 x 656 mm	315 x 856 mm	
Dimensions (WxDxH)	370x546x100 mm	370x656x100 mm	370x856x100 mm	
Base	Steel Base	Steel Base	Steel Base	
Color	Sliver / Black	Sliver / Black	Sliver / Black	

3943

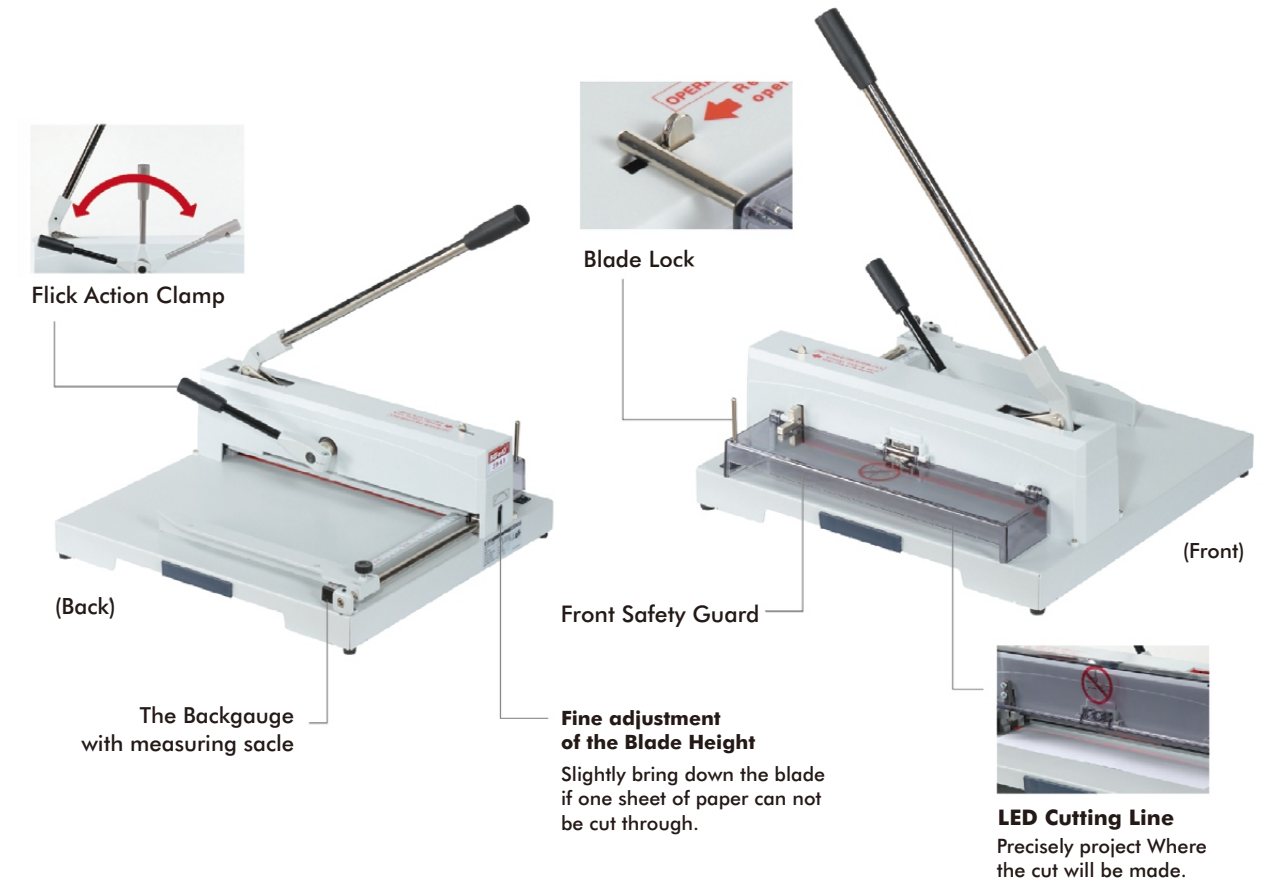

This office guillotine designed for manual operation is perfect for cutting and trimming paper stacks up to 150 sheets and cutting length up to 370 mm with the fast action clamp, hand guard, knife lock, paper, guide and fine micro adjustment of blade.



Model	3943	Spare Blade, Cutting Stick Mode: 01300255 01100773 Tools Included  For 13943
Sheets	150	
Type	Manual	
Voltage	-	
Cutting Length	370 mm	
Cutting Height	15 mm	
inserting Depth	265 mm	
Minimum Cut	40 mm	
Clamping System	Flick action clamp	
Table Size (WxD)	475 x 450 mm	
Measuring Scale (mm/inch)	On side gauge	
Optical Cutting Line	LED	
Blade Type	Regrinding	
Blade Micro Adjustment	V	
Blade Lock Device	V	
Safety Guard	On Front table	
Paper Guard	Steel	
Dimensions (WxDxH)	265 x 475 x 450 mm	
Stand	Option	
Color	Gray	

HEAVY DUTY TRIMMER

This manual office guillotine is perfect for cutting and trimming the paper stack up to 500 sheets and cutting length up to 430 mm. The machine equipped with the fast flick clamp, spindle guided backgauge, side guage with measuring scale, fine adjustment with the calibrated backgauge hand crank, front safety guard and knife locked in upper position is ideal for school and office use.

3941 



Model	3941	Spare Blade, Cutting Stick
Sheets	550	
Type	Manual	
Voltage	-	
Cutting Length	430 mm	
Cutting Height	55 mm	
Inserting Depth	405 mm	
Minimum Cut	35 mm	
Clamping System	Flick action clamp	
Table Size (WxD)	680 x 680 mm	
Measuring Scale (mm/inch)	On side gauge	Mode: 01300232 01100755 For 13941, 13946
Optical Cutting Line	LED	
Blade Type	Regrinding	
Blade Micro Adjustment	V	
Blade Lock Device	V	
Safety Guard	On Front and rear of table	Mode: 01300235 01100755 For 13942
Paper Guard	Steel	
Dimensions (WxDxH)	1070 x 740 x 680 mm	
Stand	Standard	
Color	Gray	
Tools Included		
For 13942		

HEAVY DUTY TRIMMER

This powerful and efficient cutting machine with the quality electric blade drive and LED cutting line, spindle calibrated hand crank, front safety guard is required to being operated by one person only is for precise and professional cutting use.

3952



220V

 450



LED Readout Screen
Precisely telling you where the cut will be made for model 13951S & 13952S.



Two-Hand Operation
Keep your both hands away from danger when cutting.



Fine Adjustment of Blade Height
Slightly bring down the blade if one sheet of paper can not be cut through.

Hand Wheel
To roll down the clamping bar.



Model	3951	3952	Spare Blade, Cutting Stick
Sheets	450	450	
Type	Electric		
Voltage	110V		
Cutting Length	430 mm		
Cutting Height	45 mm		
Inserting Depth	430 mm		
Minimum Cut	48 mm		
Clamping System	Spindle guided clamp		
Table Size (WxD)	625 x 700 mm		
Measuring Scale (mm/inch)	On side gauge		Mode: 01300235 01100755 For 13951, 13951S 13952, 13952S 13950
Optical Cutting Line	LED		
Blade Type	Regrinding		
Blade Micro Adjustment	V		
Blade Lock Device	V		
Safety Guard	On front and rear of table		
Paper Guard	Steel		
Dimensions (WxDxH)	1210 x 630 x 820 mm		
Stand	Standard		
Color	Gray		

Index

KW-triO reserves the right to make changes to any products or specifications without prior notice.

Series →

New arrival → *

Product →

Item No. →

Page →

Staplers No. 10

5106	5109	5270	5102
P05	P05	P05	P05

Staplers No. 10 24/6

5103T	5201	5990	5871	5665	5566	5512T	5675	5537	5547
P05	P05	P06	P06	P06	P06	P06	P07	P07	P07

MACRON GIFT SET

55Y7	5660	5568	5558H	55A3	5620	5820	6351	5403	9433
P07	P07	P08	P08	P08	P08	P08	P09	P09	P09

STATIONERY

3423	5512T	55A3M	5566M	5631	5103T	5109TM	5304M	5385	6341
P09	P10	P10	P10	P10	P10	P10	P10	P10	P11

GIFT SET EFFORTLESS STAPLER HEAVY DUTY PLIER

6339	6342M	6074	5385	5631	5618	5012	5004	5005	5160
P11	P11	P11	P12	P12	P13	P13	P13	P13	P14

STAPLER HEAVY DUTY STAPLER

5133	5793	5900	5742	5299	5001	5003	5004	5005	50SB
P14	P14	P14	P14	P15	P17	P17	P17	P17	P18

MANUAL TACKERS

50SC	50MA	5000	50LB	50LBN	50LC	50LCN	8540	8502	8512
P18	P18	P18	P19	P19	P19	P19	P20	P21	P21

STAPLE REMOVER ELECTRIC PUNCH

8513	8514	STAPLES	5091	5088	5093	508B	9591	9402	988
P21	P21	P23	P24	P24	P24	P24	P26	P26	P27

STAPLER

90P0	9060	91X8	90EO	96X8	91PO	912	9660	96PO	96EO
P27	P27	P27	P27	P28	P28	P28	P28	P28	P28

978	9760	98EO	97P0	93YO	9670	9380	9520	9330	999
P29	P29	P29	P29	P30	P30	P30	P31	P31	P32

EASY TECH POWER SAVING PUNCH

9630	9530	955C	999D	9640	9540	9556	9546	9550	955C
P32	P32	P32	P33	P33	P33	P34	P34	P35	P35

1 HOLE POWER PUNCH ROUNDER CORNER PUNCH MISCELLANEOUS

97A0	97D0	921	9772	9717	Rep Set	9522	9521	9777	92194
P36	P36	P36	P36	P36	P37	P38	P39	P40	P40

Punch

4600	4800	3A00	2450	3A02	3541	3555	3513	3713	100638
P41	P41	P41	P41	P41	P42	P42	P42	P42	P42

Punch

100639	3805	3804	9Z200/9Z201/9Z202/9Z203	2220	2240	2210	2230
P42	P42	P42	P43	P44	P44	P44	P44

Punch

2280	JD01	JD05	3305	3309	3311	EX01	2100	2090	2080
P44	P45	P45	P46	P46	P46	P46	P47	P47	P47

Pencil Sharpener

2070	2060	2062	3252	31GA	30FA	307A	306A	305A	310A
P47	P47	P47	P48	P48	P48	P49	P49	P49	P49

Stapler

305B	326A	3912	3024	3921	3911	3914	3300	3018	3919
P49	P49	P50	P50	P51	P51	P51	P51	P52	P52

Stapler

3020	3943	3941	3952
P52	P53	P54	P55